

SHENZHEN ATTEN TECHNOLOGY CO., LTD.

- Soldering Iron ●Soldering Station ●Hot Air Rework Station
- Multi-function Rework System ●BGA Rework System
- Regulated DC Power Supply ●Switching DC Power Supply
- Programmable Power Supply

ATTEN

ST-60/ST-80/ST-100

SOLDERING STATION

USER'S MANUAL

SHENZHEN ATTEN TECHNOLOGY CO., LTD.

Add: Floor 8, Building 2, Senyang High-tech Park, 7 West Road
High-tech Park, Guangming New district, Shenzhen 518132, China

Tel: +86-755-2697 6387

Fax: +86-755-8602 1337

Web: www.atten.com.cn(CN)

www.atten.com(EN)

Email: sales@atten.com.cn

THE **NO.1**
INSTRUMENTS BRAND IN CHINA
©2014 ATTEN CORPORATION
MADE IN CHINA

CBN027457 (C)

S/N

SHENZHEN ATTEN TECHNOLOGY CO., LTD.
©2014 ATTEN Corporation

Content

Content	1
Copyright	2
Symbols and Conventions	2
Assumption For User	2
Safety	2
Disclaimer	2
Item Check List	3
Product Overview	3
Features	3
Specifications	3
First Glance	4
LCD Display Panel	4
Operational Guide	5
Maintenance	9
Troubleshooting	9
Service Contact	10
Appendix	10

Warranty

This product warranty period cover 24 months from the day this product purchased. We will make free maintenance for any quality problem itself if this card and receipt provided. We will repair and return your device within 2 workdays after receiving repairing-req device.

Note: please attach this warranty card if you want your device to be repaired without charge.

Certificate of Product

Model: _____ Product NO.: _____

QC: _____ Production date: _____

Sales clerk: _____ Sale date: _____

Interchangeable soldering tip specifications (AT800 series)

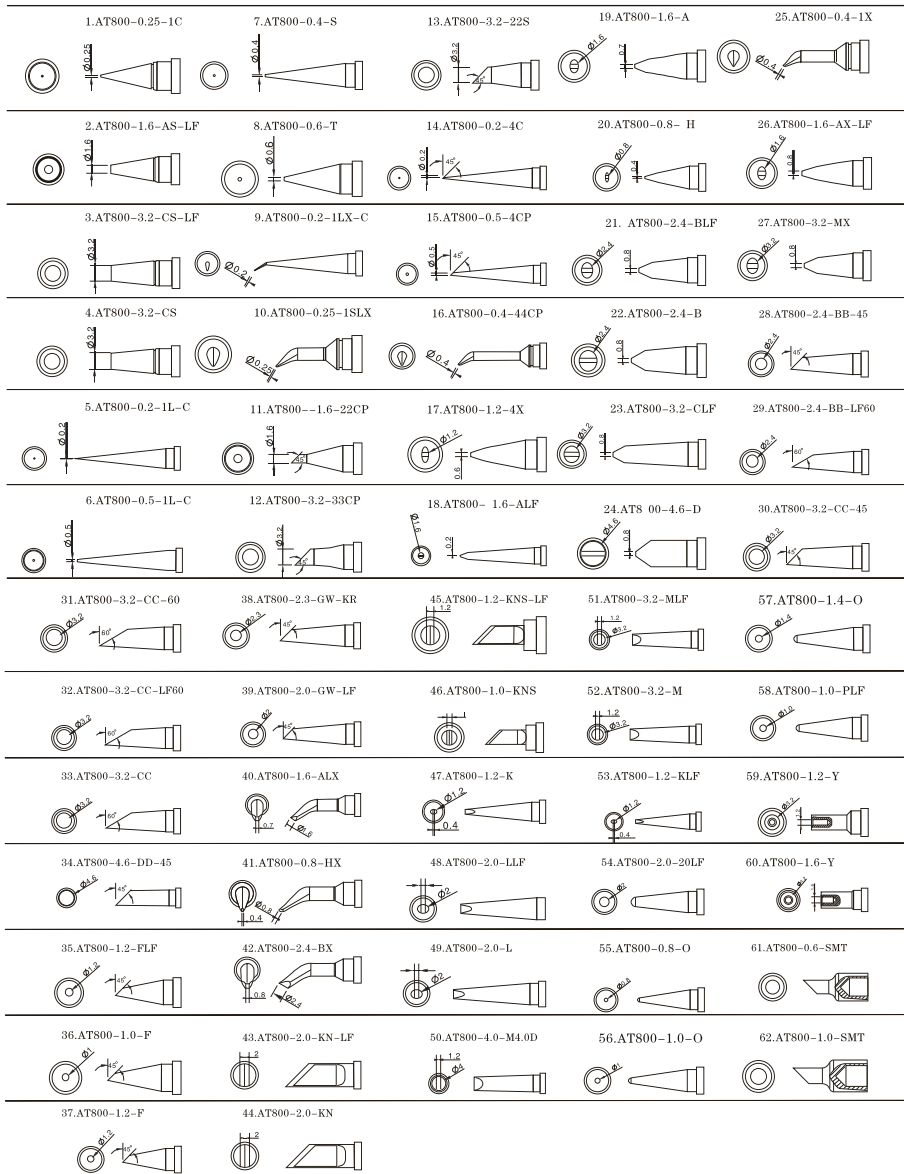

Copyright

The design of this product (including software) and its accessories is under tutelage of laws. Any action to violate relevant right of our product will be penalized through law. Please consciously observe relevant local laws in the use of this product.

Symbols and conventions

Thank you for purchasing this soldering station product. Please read this manual carefully and pay attention to warnings and precautions mentioned herein before using this product.

	Warning you against the risk of electric shock.
	Warning you against the risk of physical injury.

Assumption for user

We assume that user have common sense and basic relevant electrical operation knowledge before using this product. This device is not intended for use by persons (including children) with limited physical, sensory or mental aptitude, or by persons who lack knowledge or experience in handling the device. This appliance can be used by children aged from 8 years and above and persons with reduced physical, sensory or mental capabilities or lack of experience and knowledge if they have been given supervision or instruction concerning use of the appliance in a safe way and understand the hazards involved. Children shall not play with the appliance. Cleaning and user maintenance shall not be made by children without supervision.

Safety

WARNING: The soldering tip temperature can reach 150°C~480°C as this product in working status. User should obey following rules rigorously in view of improper operation will cause fires or burns.

- Never touch soldering tip and surrounding metal part of soldering tip before soldering tip cool down completely.
- Never use this product around flammable objects.
- Always turn switch off after operation and always turn switch off for temporary not-operation.
- User must waiting soldering iron cool down completely after turning switch off for the replacement of soldering tip and internal parts.
- Never operate on product for those who have no experience or have no basic knowledge for the circumstance of no guidance.
- Keep this product out of reach of children.
- Never place product and part of it in water or operate as your hands are wet.
- Please keep workplace well ventilated for fumes produced in soldering work.
- Never play with others while using this product.

Disclaimer

- For physical injuries and possessions loss caused by those reasons which are not related to product quality such as operating without following manual guide, natural disasters or force majeure, we take no responsibility for that.
- Under the supervision of Shenzhen Atten Technology Co., Ltd, this manual has been compiled and published which covered the latest product description and specification. The content of

- this manual is subject to change without notice.

ATTENTION: To avoid damaging to unit and keep operation safe, please read the instruction manual ahead and keep it accessible for any operator.

Item check list

Name	Quantity
Soldering station	1 Unit
Soldering iron	1 PCS
Iron supporting stand	1 Unit
Power cord	1 PCS
Manual	1 Copy
Sponge	1 Unit

Product overview

ST-60/ST-80/ST-100 is a new designed digital soldering station which got better performance and is more convenient and safer to use. And it has been widely used in colleges & universities, institutes, industrial production line and so on.

Features

- Brand new design and LCD display which can display various setting values.
- New designed menu enable system setting easier.
- Visual control over operation process which Analogue heating-up status bar to indicate heating up status and visual setting.
- 3 keys to store and retrieve frequently used temperature values quickly.
- Provide temperature locking function to make production line management convenient.
- Smart standby, shutdown function, adjustable standby time and adjustable shutdown time enable more energy saved and environment friendly.
- Touchtone could be turned off and on.
- Temperature calibration was designed to be more precise and more convenient to keep this product in good performance for a long time.
- This product was designed with low-voltage heating heater which is completely separated from power supply to keep soldering work safer.
- This product was designed to be compatible with general 900M series (only for ST-60/ST-80) soldering tip which was assembled separately with heating heater to cut user costs down.
- Separated iron stand to save room and to make soldering station layout easier.

Specifications

	ST-60	ST-80	ST-100
Input Voltage	AC (100V/110V/120V	220V/230V/240V	50/60Hz(optional)
Power	60W	80W	100W
Heating element voltage	26VAC	28VAC	24VAC
Temperature Range	150-450°C/302-842 °F	150-480°C/302-896 °F	150-480°C/302-896 °F
Temperature calibration range	± 50°C/ ± 90°F	± 50°C/ ± 90°F	± 50°C/±90°F
Temperature precision	± 15°C	± 10°C	± 10°C

Interchangeable soldering tip specifications (900M series)

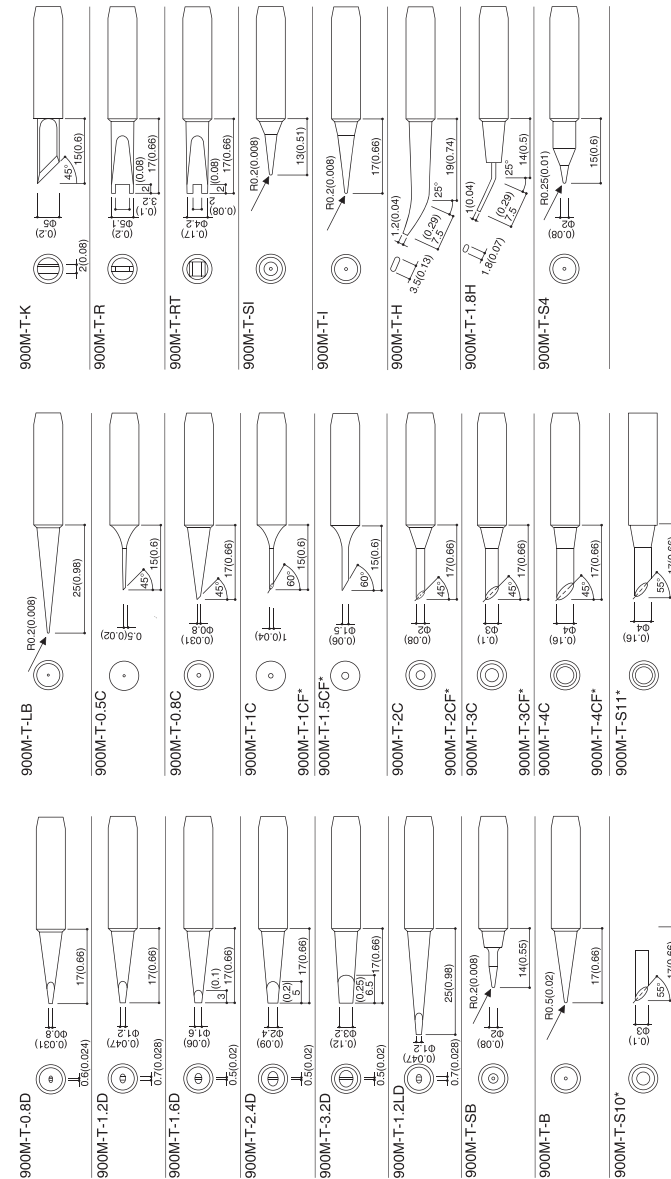

Parts List

Number	Material name	Number	Material name
1	Power cord	16	Key group 1
2	Fuse(T1.0A 220V/230V240V),(T2.0A 100V/110V/120V)	17	Key group 2
3	Male socket	18	Power switch
4	Soldering iron stand	19	Output receptacle
5	Cleaning sponge	20	Soldering iron handle cables
6	Housing	21	Soldering iron handle end sleeve
7	PCBA fixing screws	22	Soldering iron handle end
8	PCBA board	23	Soldering iron handle sleeve
9	Transformers fixing screws	24	Soldering iron handle
10	Transformers	25	Heating element unit
11	Bottom housing	26	Fixing base
12	Fixing screws for bottom housing	27	Soldering tip
13	Machine base	28	Fixing swivel nut
14	Front panel	29	Soldering tip fixing tube
15	Transparent mask		

	ST-60	ST-80	ST-100
Temperature Stability	± 2°C (in still air, without load)		
Automatically stand-by time	1-120 minutes		
Standby temperature	150°C		
Automatically shut down time	1-120 minutes		
Temperature regulation	5 digits(default)/1digit (fine tuning)		
Heating element	High performance dual-wire heater	High end quad-wire heater	Silver alloy heater
Temperature lock	Yes		
Beeping	Yes		
Tip-to-ground impedance	< 2 Ω		
Tip-to-ground voltage	< 2 mV		
Volume	175(L)*115(W)*95(H)mm		
Net Weight	1.85KG	2.36KG	2.4KG
Soldering tips	900M series(Appendix)	900M series(Appendix)	AT800 series(Appendix)

※ The above specifications are subject to further change without notice and refer to actual products.

※ It is not recommend to set working temperature above 450°C for a long time to keep this product lifespan longer.

First glance



- ① Iron handpiece
- ② Iron stand
- ③ Preset key 1
- ④ Preset key 2
- ⑤ LCD screen

- ① Preset key 3
- ② Up key
- ③ Down key
- ④ Power switch
- ⑤ Handpiece receptacle

LCD display panel

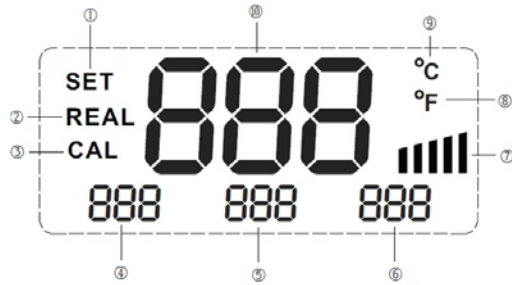

LCD display Description:

- ① SET (Set Mode): indicate soldering station enter setting mode;
- ② REAL (Real Mode): indicate soldering station enter real-time display mode;
- ③ CAL (Calibration): indicate soldering station enter temperature calibration mode;
- ④ Show the temperature value stored in express store-and-retrieval channel 1
- ⑤ Show the temperature value stored in express store-and-retrieval channel 2
- ⑥ Show the temperature value stored in express store-and-retrieval channel 3
- ⑦ Analogue heating-up status bar to show current heating strength.
- ⑧ Indicate current temperature scale is Fahrenheit.
- ⑨ Indicate current temperature scale is Celsius.
- ⑩ Display soldering tip real-time temperature values.

Operational guide

1. Connection

- ① Plug soldering iron power end into receptacle on soldering station front panel and place soldering iron handle in soldering iron supporting stand.
- ② Plug power cord female plug into receptacle on soldering station rear panel.(Please assure power supplied is fit for this product) .

2. Power-on

Turn switch on after power cord connection. LCD display panel will display system version number for 1 seconds, then LCD display panel will show last set temperature value and show "SET" simultaneously(Figure 1).3 seconds later, display panel will show soldering iron real-time temperature value and "REAL" at the same time(Figure 2).

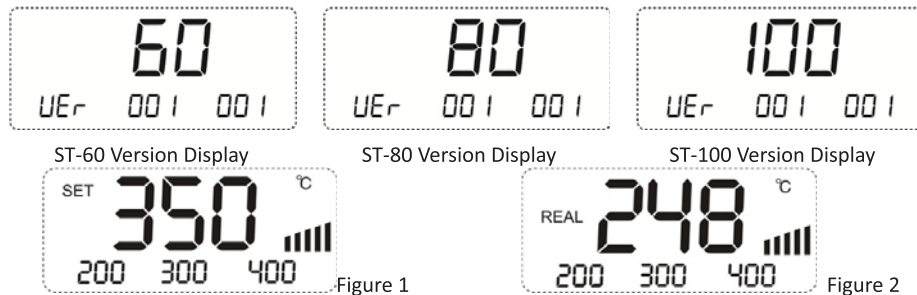

3. Setting temperature

In normal working state, press ▲ or ▼ to adjust temperature and enter temperature setting mode

Fault Code Or Malfunction Description	Causes For Malfunction
	<ul style="list-style-type: none"> ● Short circuit for heater or soldering iron wires
E-1: Abnormal heating-up alarming	<ul style="list-style-type: none"> ● Open circuit for heating element. ● Connection error for heating element.
E-2: Open circuit alarming for sensors	<ul style="list-style-type: none"> ● Heater damaged. ● Wiring error of heating element.
Not well connected	<ul style="list-style-type: none"> ● Check power cord plug and fuse (Please replace it with same specification).
Temperature displayed is not correct	<ul style="list-style-type: none"> ● Please check whether the soldering iron is damaged and calibrate it again.
Unreadable code	<ul style="list-style-type: none"> ● Switch power off and restart soldering station.

※After malfunction occurred, maintenance work should be done through assigned technician by original manufacturer or qualified technician.

Service contact

Service Department Tel : +86-755-26976387

Appendix

Machine exploded view:

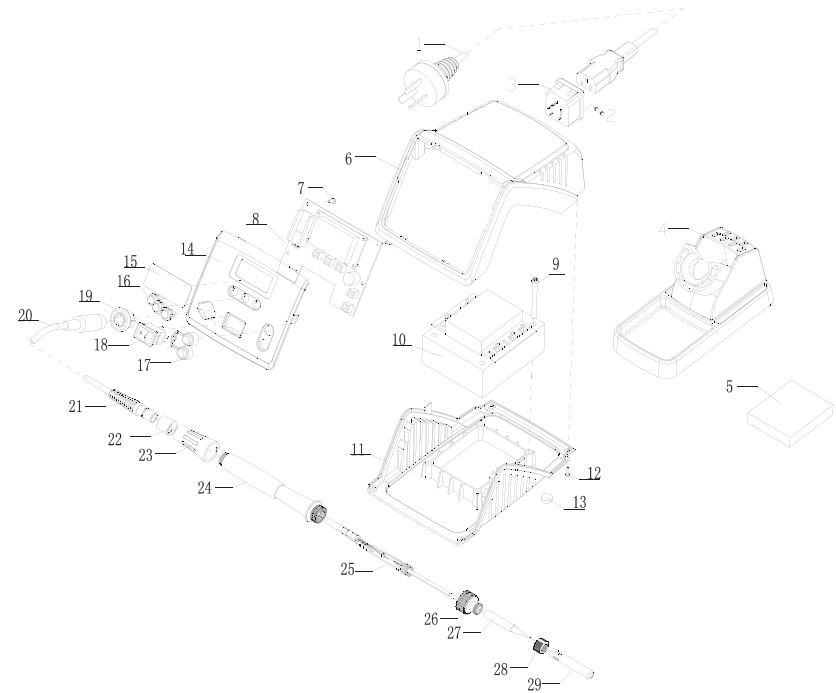

touchtone setting mode and display panel will show current touchtone setting status. Press ▼ or ▲ to set touchtone state and press #3 to save it.

Note: Beeping function is enable as setting content is "ON", and now there will arise short beep for each operation on control panel to call your attention.



Figure 21



Figure 22

13. Restore factory settings

12.1 In system setting mode, press ▼ to go to third setting page(Figure 8). Then press #1 to enter factory settings restoration mode. Press ▼ or ▲ to choose resetting page or not. After resetting, soldering station system settings will be reset as follows:

CAL (User temperature calibration value): Cleared.

FIN (fine-tuning): OFF

C-F (Temperature scales): Celsius

STB (Automatic Standby): OFF

SDN (Automatic shutdown): OFF

BL (Beeping): ON

Express temperature 1: 200°C

Express temperature 2: 300°C

Express temperature 3: 400°C



图 23



图 24

14. Exiting system setting quickly

14.1 In system setting mode, press ▼ to go to third setting page(Figure 8) as user want to exit system setting mode quickly(Default automatic-exiting time is 10 seconds),then press #2 to exit system setting mode.

Maintenance

- To ensure this product lifespan will not be shortened, user must pay attention to following matters in using this product.
- Do not use this equipment for other purposes except soldering work.
- Do not rack soldering irons handle to remove residue solder on soldering tip which will damage this unit.
- Do not tamper with this product and its internal components.
- Do not modify this product and its internal parts.
- Please choose accessories produced by original manufacturer for replacing parts.
- Please grasp plug rather than cables for pulling plug out.

Troubleshooting

Fault Code Or Malfunction Description	Causes For Malfunction
E-0:Abnormal heating alarm of heater.	<ul style="list-style-type: none"> ● Transformer damaged ● Power MOSFET damaged

(Figure 4),"SET" will show on LCD display panel simultaneously. Pressing and holding ▲ or ▼ can adjust temperature quickly. Stop pressing will cause soldering station store setting value automatically and exit from temperature setting mode.

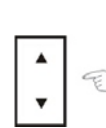

Figure 3



Figure 4

4. Storing and retrieving temperature values quickly

- Retrieve temperature values: in normal working state, press 1, 2, 3(Figure 5) to retrieve temperature values stored in memory and set retrieved value as current working temperature.
- Store temperature: in normal working state, press and hold (over 3 seconds) 1, 2, 3 to store current set temperature values into memory.

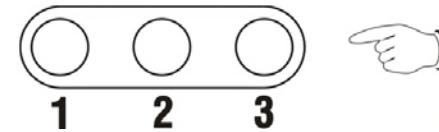

Figure 5

5. Locking operation keys

- In normal working state, pressing and holding 1, 2, 3 simultaneously over 3 seconds can lock current set temperature value. Now any operation on control panel will make no sense which indicate operation keys is locked.
- In key-locking mode, pressing and holding 1, 2, 3 simultaneously over 3 seconds can remove locking state as you want to.



Figure 6

6. System setting

6.1 As user need to set system parameters, user should enter system setting mode first. Press and hold ▲ and ▼ simultaneously over 3 seconds to enter system setting mode. User can turn setting pages by pressing ▲ and ▼ in system setting mode (Figure 7, 8, 9).

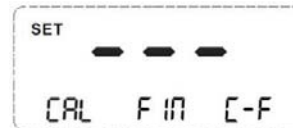

Figure 7

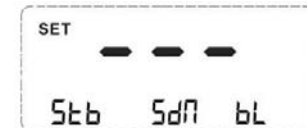

Figure 8

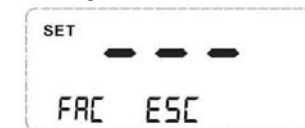

Figure 6

7. Manually temperature calibration

7.1 In first system setting page ,press 1 to enter temperature calibration mode, and "CAL" will show on display panel on which also shows last calibration value(Figure 10,calibration value is 0°C).

7.2 In calibration mode, press ▲ and ▼ to set calibration temperature values whose range is -50°C ~ 50°C (-90°F~+90°F).Calibration value will be negative as actual-measured temperature value is smaller than the value showed on display panel. Calibration value will be positive as actual-measured temperature value is bigger than the value showed on display panel.

7.3 Press #1 to store calibration temperature values after input calibration values.



Figure 10

Calibration method:

Please prepare temperature probe, measure soldering tip temperature and record it(Please add some solder on soldering tip to let soldering tip and probe contact closely). Denote actual measured temperature as T1(like 320°C) and denote displayed temperature value as T2(like 350°C).So calibration value should be -30°C(T1-T2) and then press ▼ to input "-30".

8. Trimming function is turned on. Enable fine tuning.

8.1 In system setting mode, press #2 to enter fine tuning setting mode and display panel will show current fine tuning status now. Press ▼ or ▲ to enable or disable fine tuning function and then press #2 to save it.

Note: As setting content is "ON", the fine tuning function is turned on which make temperature adjusted at 1 digit for each pressing. Otherwise, temperature will be adjusted at 5 digits for each pressing. This is quite fit for different operation requirements.



Figure 11



Figure 12

9. Switching temperature scales

9.1 In system setting mode, Press #3 to enter temperature scales setting mode and display panel will show current temperature scale now. Press ▼ or ▲ to switch temperature scales between Fahrenheit and Celsius, then press #3 to save it(Figure 13,Figure 14).



Figure 13



Figure 14

10. Setting automatic stand-by time

10.1 In system setting mode, press ▼ to go to second setting page(Figure 8). Then press #1 to enter

stand-by time setting mode and display panel will show current stand-by time. Press ▼ or ▲ to set stand-by time and press #1 to save it.

Note: Stand-by time can be set between 1 minute and 120 minutes and stand-by function will be disabled as setting content is "OFF"(Figure 15).After enabling stand-by function, soldering station will enter stand-by state if no soldering work or any other control panel operations taken throughout during stand-by time, and the temperature will decline to 150°C and be stabilized around 150°C.In stand-by state, picking solder iron handle or any operation on control panel can wake up soldering station and soldering station will continue to work in preset temperature value.



Figure 15



Figure 16



Figure 17

11. Setting automatic shutdown time

a) In system setting mode, press ▼ to go to second setting page(Figure 8). Then press #2 to enter shutdown time setting mode and display panel will show current shutdown time set value. Press ▼ or ▲ to set shutdown time as 1 minute ~ 120 minutes or OFF and press #2 to save it. It will disable automatic shutdown function as setting content is "OFF".

Note: Automatic shutdown function only can be enabled as automatic stand-by function set on. Soldering station will enter shutdown state, stop heating and don't turn off display panel until temperature has declined to 100°C as the time in stand-by state exceeds preset shutdown time. After entering shutdown mode, any operation on control panel will make no sense after entering shutdown mode. The soldering station only can exit this mode after user switch power off and restart it.

b) In shutdown mode, soldering station is not in real power-off state which still consumes little energy as soldering station is well connected with power supply. To ensure safety, please turn off power switch or pull power plug out.



Figure 18



Figure 19



Figure 20

12. Touchtone function

12.1 In system setting mode, press ▼ to go to second setting page (Figure 8). Then press #3 to enter